



Probably the „fastest“ enclosure in the world

Sample configuration



Vitaro®



19" enclosure system **Vitaro**

Vitaro can be assembled within less than 60 seconds:

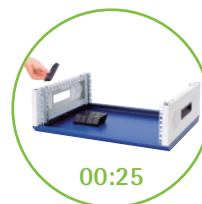
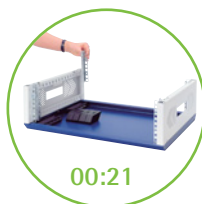
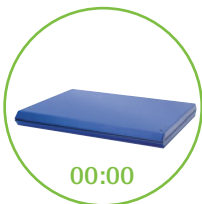

- universal enclosure system:
 - 19" enclosure
 - universal enclosure
 - wall-mounting enclosure
- extremely short assembly time
- no screws required for assembly due to special fixing system*
- attractive design
- light aluminium construction
- stackable
- integrated handles
- assembly kit system requiring minimum storage and transportation space
- various expansion options
- modular accessories
- protection system IP 20
- special models available on request

* Enclosure can also be assembled using screws additionally.



One basic enclosure, three options

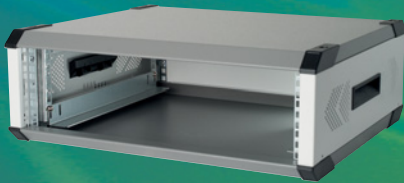

Model 1: 19" enclosure 3/4/6 U

The enclosure has vertical mountings that are inserted without tools and is ready for you to install 19" components.

Installation dimensions comply with IEC 60297-3-100

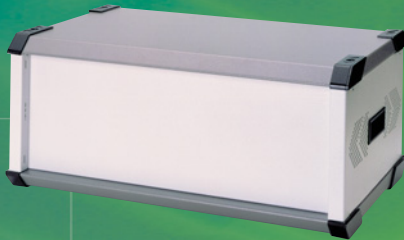

Model 2: Universal enclosure

We can customise this universal enclosure to your requirements on request, whether you require stamps, embossing or printing.



Model 3: Wall-mounting enclosure

You can use a wall mounting set (see page 35) to transform enclosure models 1 or 2 into a wall-mounting enclosure.



Vitaro basic enclosure

Application:

can be used as a 19" enclosure, wall-mounting enclosure or universal enclosure for customised use; ideal for installing 19" components acc. to IEC 60297-3-100 and 297-3-101.

Construction:

aluminium shell construction with plug-in tab system; no tools required for assembly. 4 screws can be used for extra security (included in delivery).

Material:

top/ bottom panels: aluminium 1.5 mm
side panels: aluminium 1.2 mm

Finish:

top/bottom panels:
RAL 7037 dust grey
side panels:
RAL 7035 light grey

Degree of protection:

IP 20

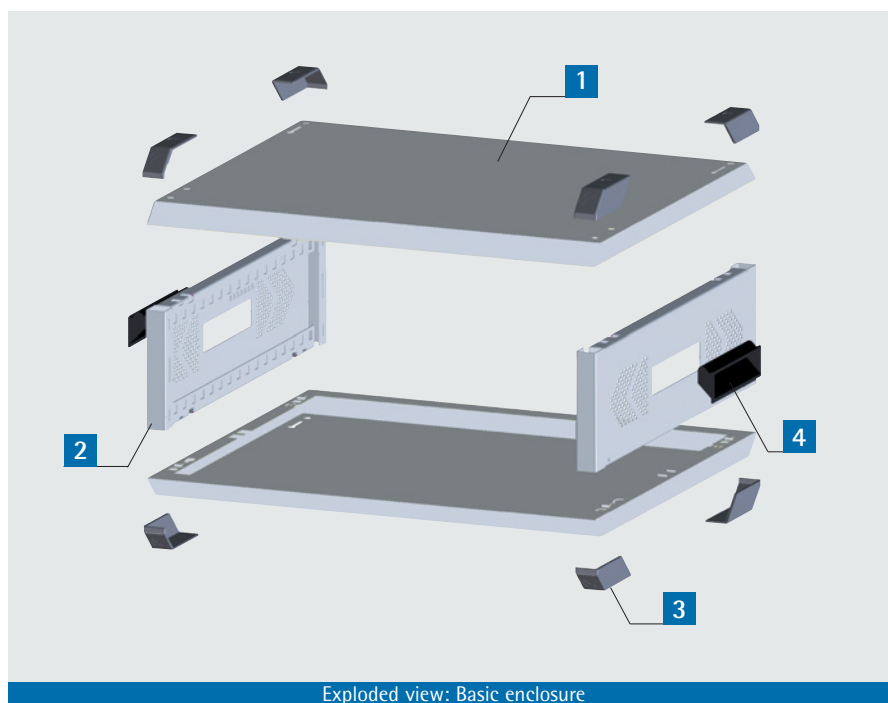

Exploded view: Basic enclosure

Installation depth d=D-46 mm, enclosure width W = 537 mm. Additional enclosure sizes (e.g. 84 HP, 63 HP, 42 HP) are available on request.

Delivery

Item	Pc.	Description
1	2	Top/ bottom panels
2	2	Side panels
3	8	Decorative corners, stackable
4	1	Assembly set: 4 enclosure feet, 2 handles, 4 retaining screws

D mm	Description	Order no.
350	Basic enclosure 3 U	195-313-00
450		195-413-00
550		195-513-00
350	Basic enclosure 4 U	195-314-00
450		195-414-00
550		195-514-00
350	Basic enclosure 6 U	195-316-00
450		195-416-00
550		195-516-00

Vitaro expansion kit 19" enclosure

The basic enclosure can be transformed into a full 19" enclosure using plug-in vertical mountings. No tools are required.

Material:

sheet steel 1.5 mm

Finish:

galvanised

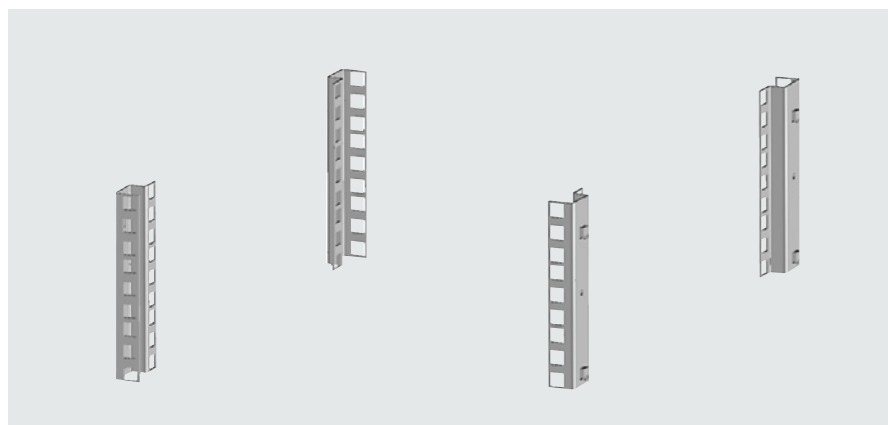

Please order rear panel separately (see page 34).

Delivery

Item	Pc.	Description
1	4	Vertical mounting

Expansion kit	Order no.
3 U	195-053-00
4 U	195-054-00
6 U	195-056-00



19" rear panel

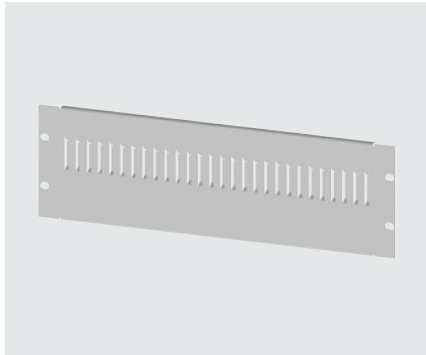

- ventilated or closed
- assembly material included

Material:

aluminium 1.5 mm

Finish:

RAL 7035 light grey

Height	Feature	Order no.
3 U	not ventilated	195-023-00
	ventilated	195-023-10
4 U	not ventilated	195-024-00
	ventilated	195-024-10
6 U	not ventilated	195-026-00
	ventilated	195-026-10

Sliding rails, adjustable height

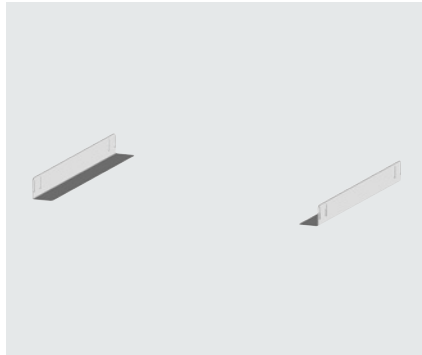

- assembly material included

Material:

sheet steel 1.5 mm

Finish:

galvanised

Load capacity:

15 kg/ pair

Description	Order no.
for D=350 mm	195-382-00
for D=450 mm	195-482-00
for D=550 mm	195-582-00

Vitaro expansion set universal enclosure

You can customise our basic enclosure using **customised front and rear panels** (screens, stamps, embossing).

You can find plug-in installation / mounting plates for horizontal and vertical installation in the accessories section on page 35.

Delivery

Item	Pc.	Description
1	1	Front panel, plug-in
2	1	Rear panel, plug-in

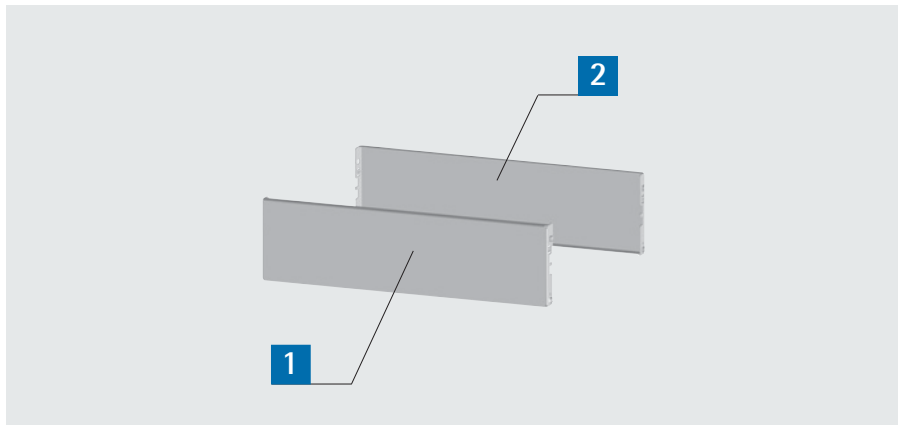

Expansion kit	Order no.
3 U	195-063-00
4 U	195-064-00
6 U	195-066-00



Door with plexiglas pane, plug-in

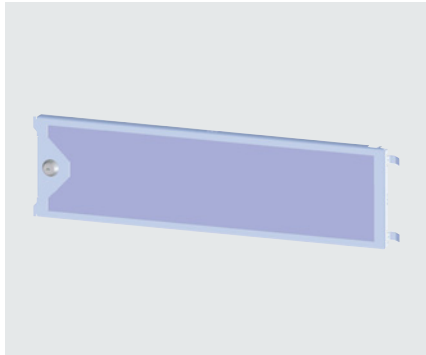

- with plexiglas pane and cylinder sash fastener
- demountable without tools

Material:

stackable door: aluminium 1.5 mm
 door: plexiglas
Finish: RAL 7035 light grey

Description	Order no.
3 U	195-073-00
4 U	195-074-00
6 U	195-076-00

Swing door with frame

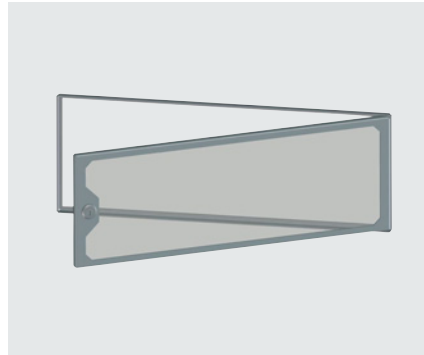

- to be screwed onto the enclosure
- with plexiglas pane and cylinder sash fastener

Material:

frame: sheet steel 2 mm
 swing door: aluminium 1.5 mm
 door: plexiglas 4.0 mm
Finish: RAL 7035 light grey

Description	Order no.
3 U	195-073-12
4 U	195-074-12
6 U	195-076-12

Mounting plate, plug-in

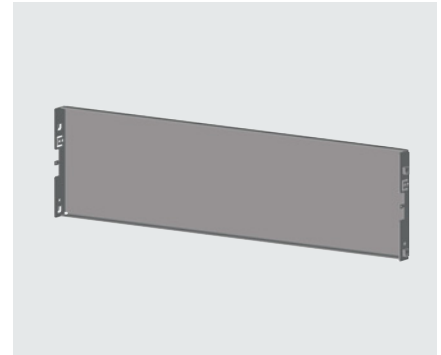

- for vertical mounting
- can be inserted at different depths

Material: aluminium 1.5 mm
Finish: RAL 7035 light grey

The mounting plate 3 U can also be installed horizontally in all enclosure sizes as a shelf.

Description	Order no.
3 U	195-063-02
4 U	195-064-02
6 U	195-066-02

Earthing set

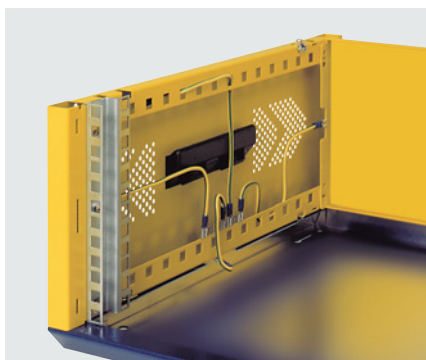

- for earth connection of all enclosure parts acc. to VDE

Description	Order no.
for 19" enclosure	195-080-10
for desktop enclosure	195-080-12
for universal enclosure	195-080-12

Blind cover set

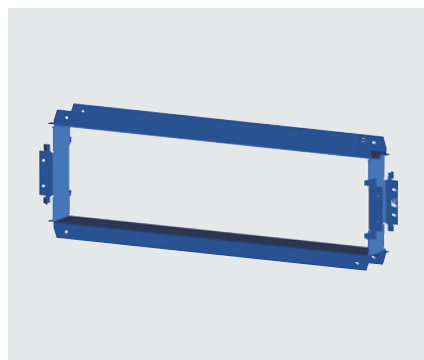

- for extension components installed 50 mm towards the rear
- 2 horizontal and 2 vertical panels included
- self-locking, no assembly material required

Material: aluminium 1.0 mm
Finish: RAL 7035 light grey

Description	Order no.
3 U	195-083-10
4 U	195-084-10
6 U	195-086-10

Wall mounting set

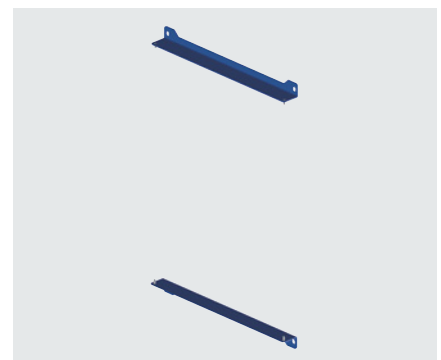

- fits all Vitaro models
- no tools required for mounting brackets to the enclosure

Material: sheet steel 2.0 mm
Finish: RAL 7035 light grey

Description	Order no.
for D=350 mm	195-380-00
for D=450 mm	195-480-00
for D=550 mm	195-580-00



Fan support with 12 V fan

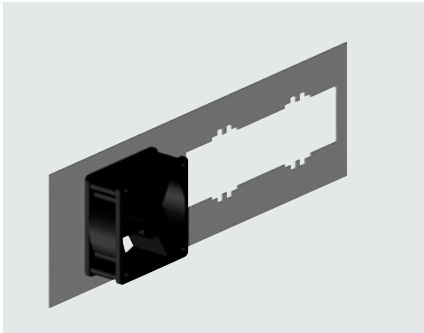

- plugs into the side wall
- high-quality PAPST-fan
- flow rate: 40 m³/h
- noise level: 40 dB (A)

Material: aluminium 1.0 mm

Description	Order no.
for D=350 mm	195-380-10
for D=450 mm for D=550 mm	195-480-10

Screw set M 5 (50-fold)



- necessary for mounting of 19" components into enclosures
- included in delivery:
 - 50 oval head screws M 5 x 12
 - 50 cage nuts M 5 - 8
 - 50 decorative washers M 5 with collar, flattened

Order no.
630-991

Prop-up and carrying handle



- handle can be set in 30° steps by pressing a button to snap it into place

Finish:

handle: RAL 9011 graphite black
handle extrusion: anodised
button, screw blind: plastics, black

Load capacity:

50 kg

Order no.
195-080-30

Front panel fixing (50-fold)



- no cage nuts required
- to mount lightweight 19" components such as dummy or front panels
- clamping range (front panel + grid): 4 - 6 mm
- consisting of:
 - 50 lens head screws M 5 x 12
 - 50 washers for screws M 5, flattened

Order no.
630-991-10